

AUX-IN on the head unit of AlfaRomeo

(A head unit made in Blaupunkt ,for Alfa147 and Alfa156)

At first AlfaRomeo's head unit(made in Blaupunkt) does not have AUX-IN.However,you can add AUX-IN by two next methods.

1.When your car has CDC, use Audio Selector.

Fig .1

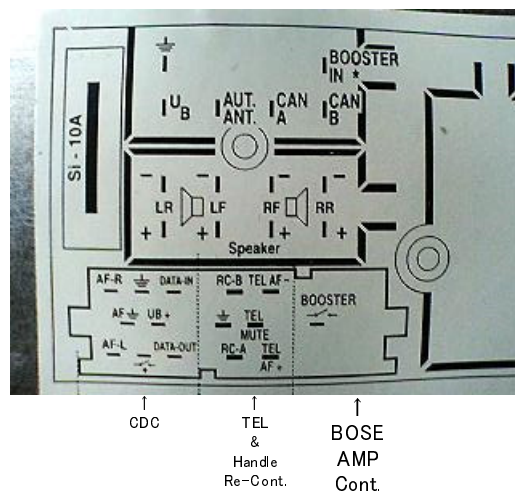
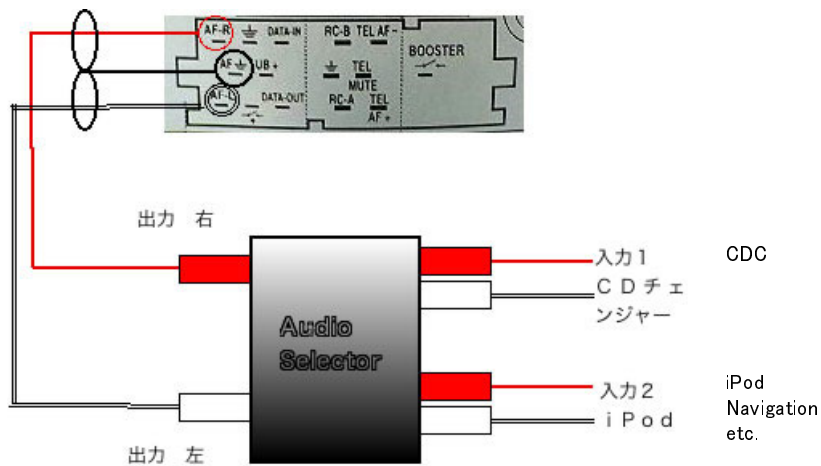

2.When your car does not have CDC, attach a switch like figure 2.

Fig.2

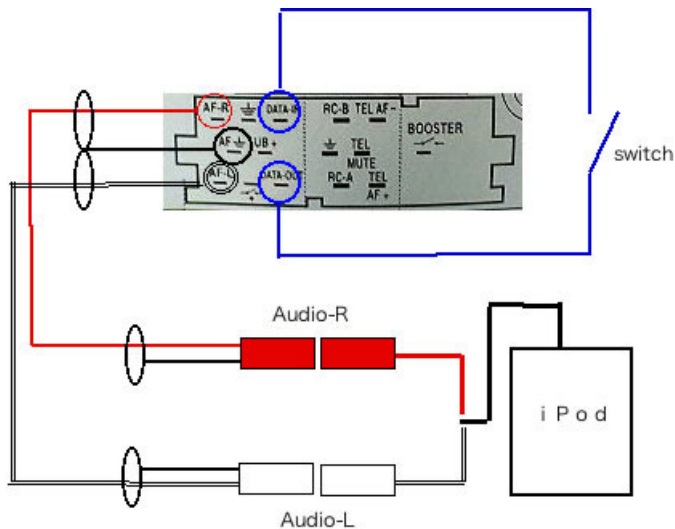

Because the **output is low** in the case of **iPod**, it is needed the amplifier . I use **Belkin Auto Kit for iPod** as an amplifier and a power supply.

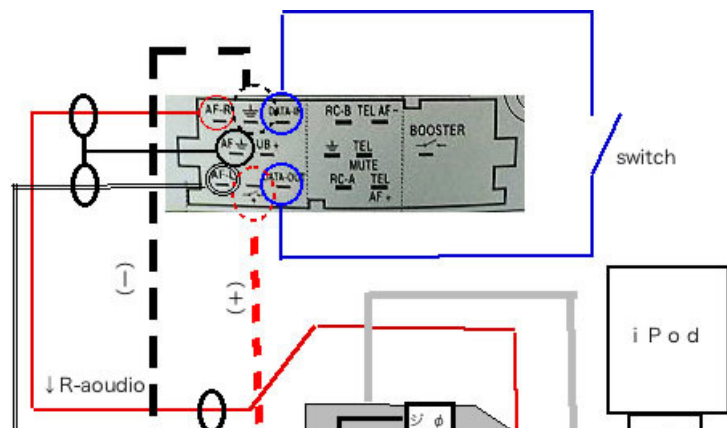

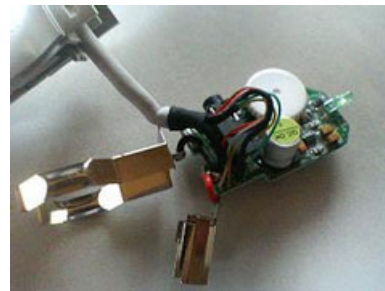

In case of Alfa,probably a CDC protocol of Blaupunkt is compatible with C-bus(Cralion).(CDC of Alfa156SW is made in Clarion.)
 You can use a connector of CDC and make AUX-IN.
 Head Unit accepts the input from CDC if you **jump DATA-IN and DATA-OUT**.

Attention:

A choice method of AUX-IN

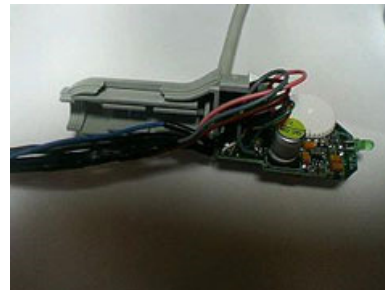

When use **AUX-IN**

Operation order

1. Switch off HeadUnit
2. Switch on the switch of Fig.2
3. Switch on Head Unit
4. AUX-IN use is possible



Audio

Power to
Belkin(iPod)

When use **CD of HEAD UNIT**

Operation order

1. Switch off HeadUnit
2. Switch off the switch of Fig.2
3. Switch on Head Unit
4. CD use is possible

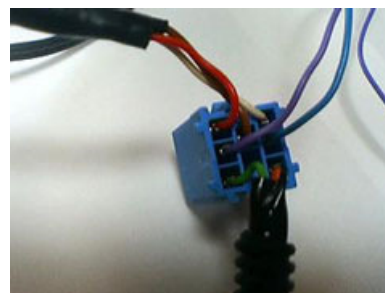

Switch



Sorry to say this IS'NT responsible for your result!!

written by Ken ,in Japan